

Detail Drawing - Inward Open Window

Frame 60 / Sash Z58

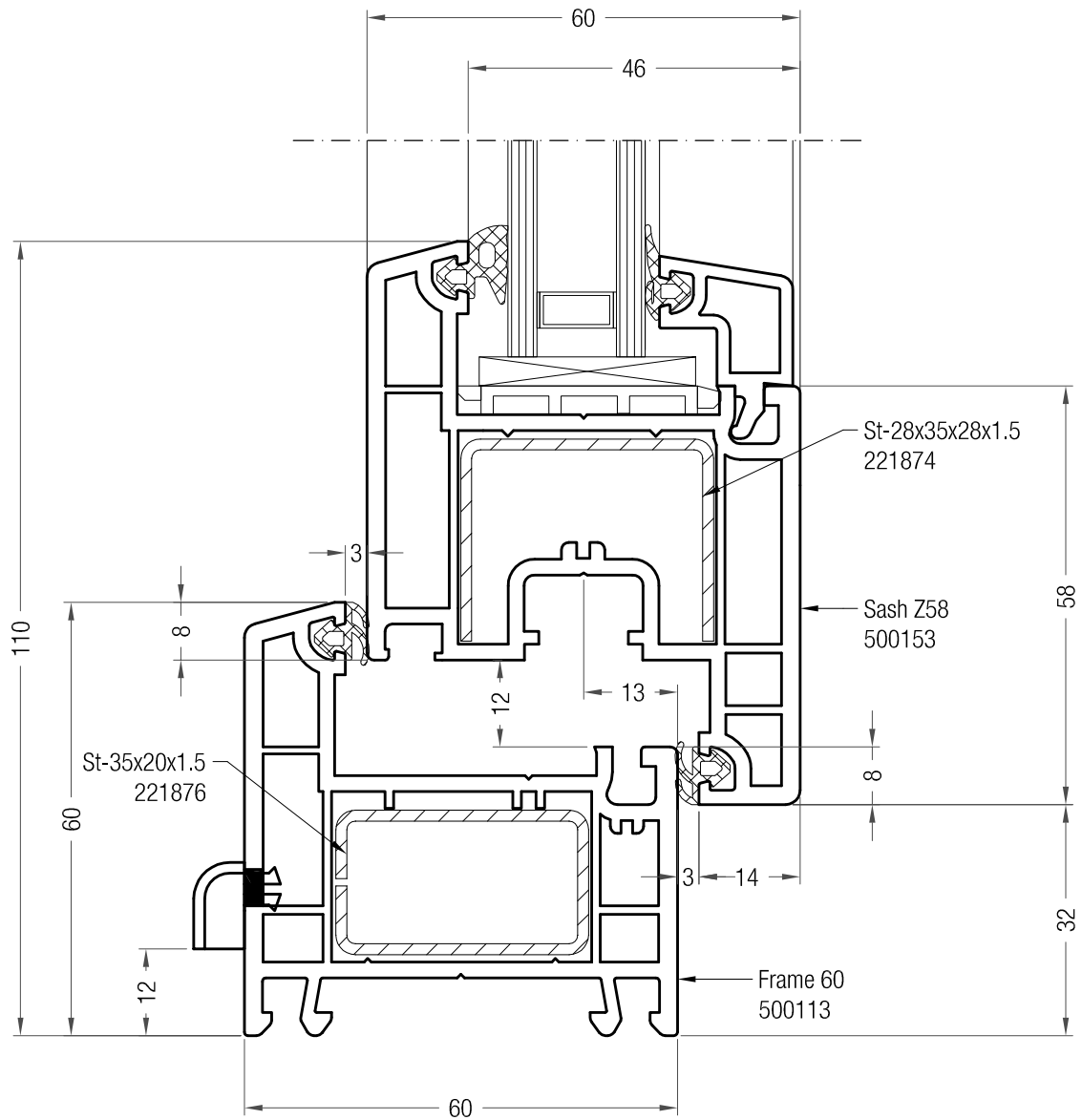
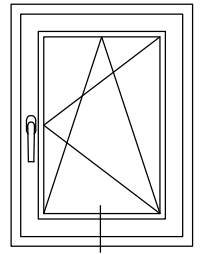

Detail Drawing - Inward Open Window with Fixed Side-Window

Inward Window Sash Z58 / Mullion T82

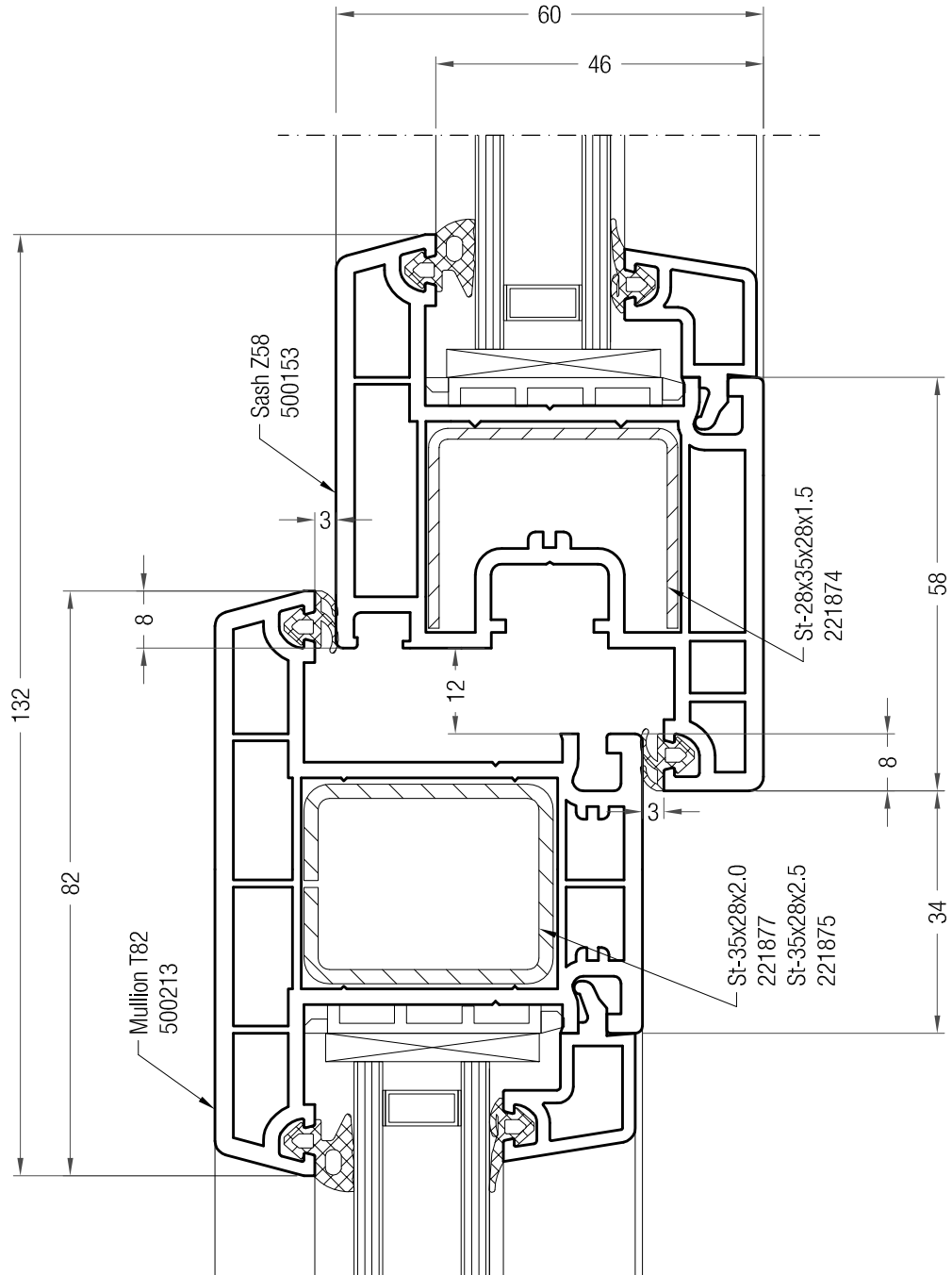
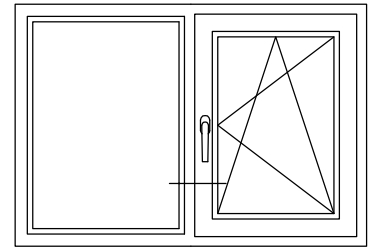

Detail Drawing - 2-Panel Inward Open Window

Inward Window Sash Z58 / Mullion T82

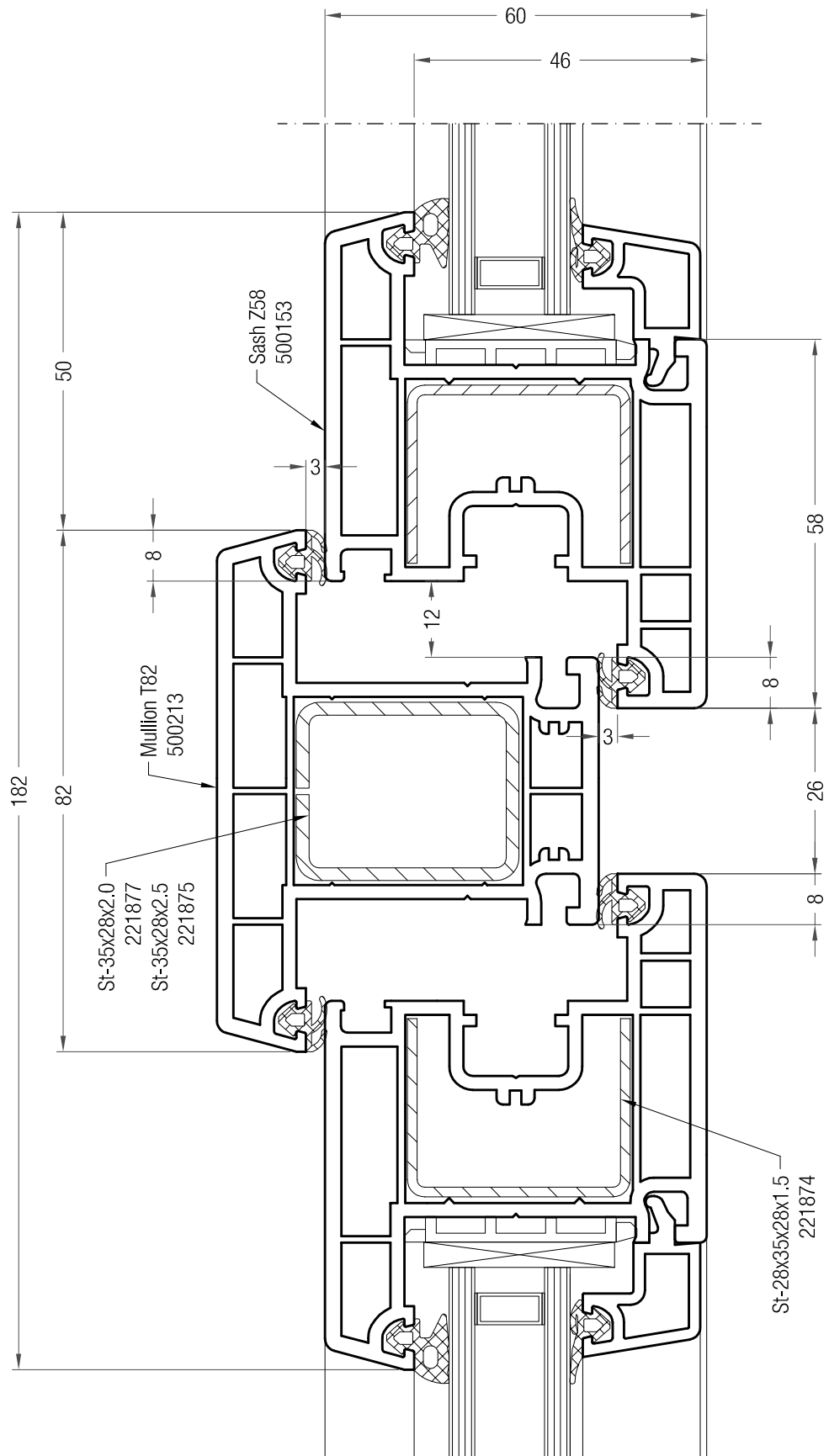
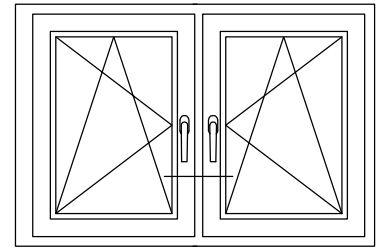

Detail Drawing - Double-Leaf Inward Open Window

Inward Window Sash Z58 / Dummy Mullion

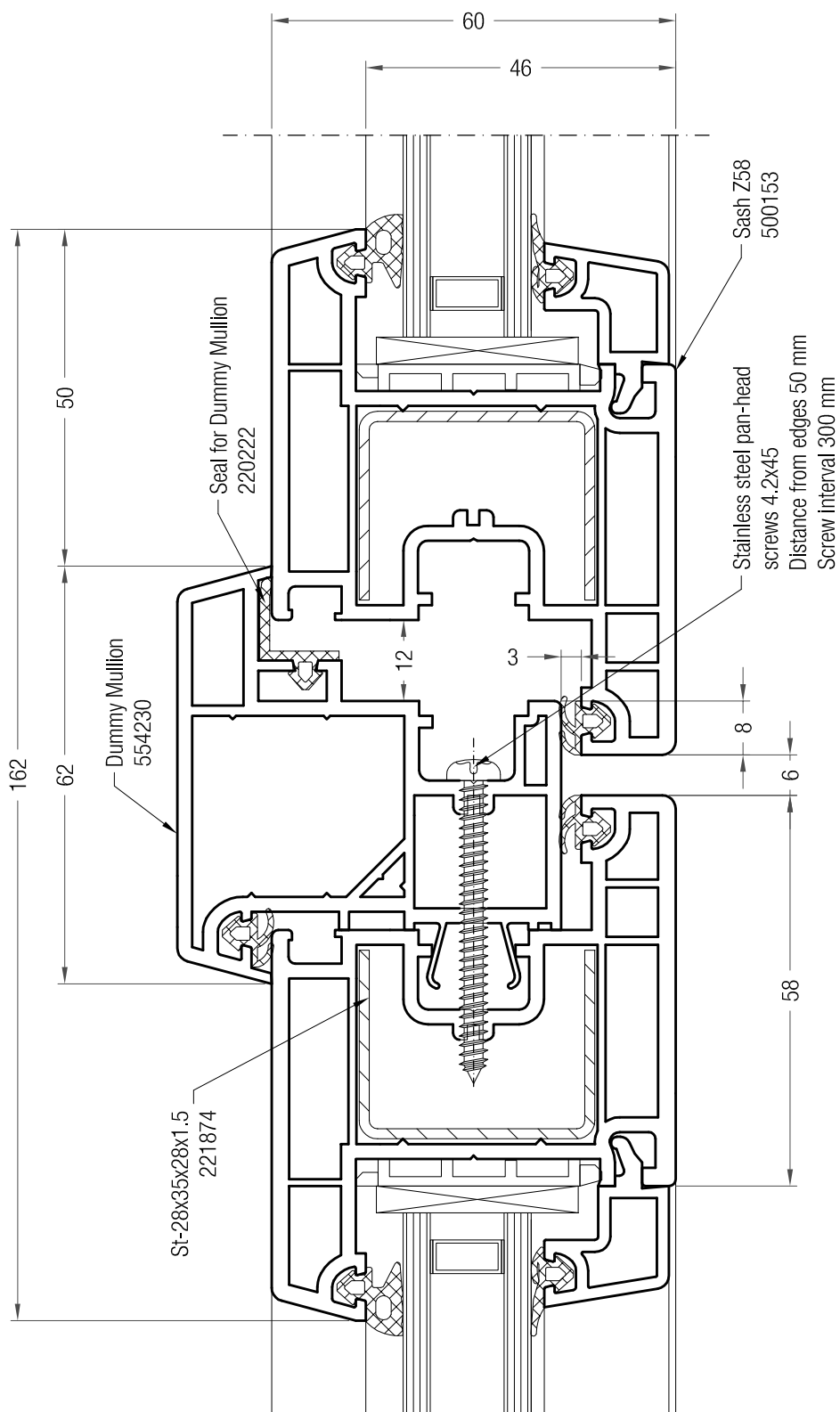
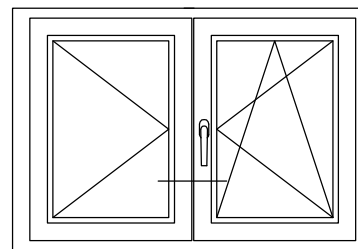

Detail Drawing - Outward Open Window

Frame 60 / Outward Window Sash T77

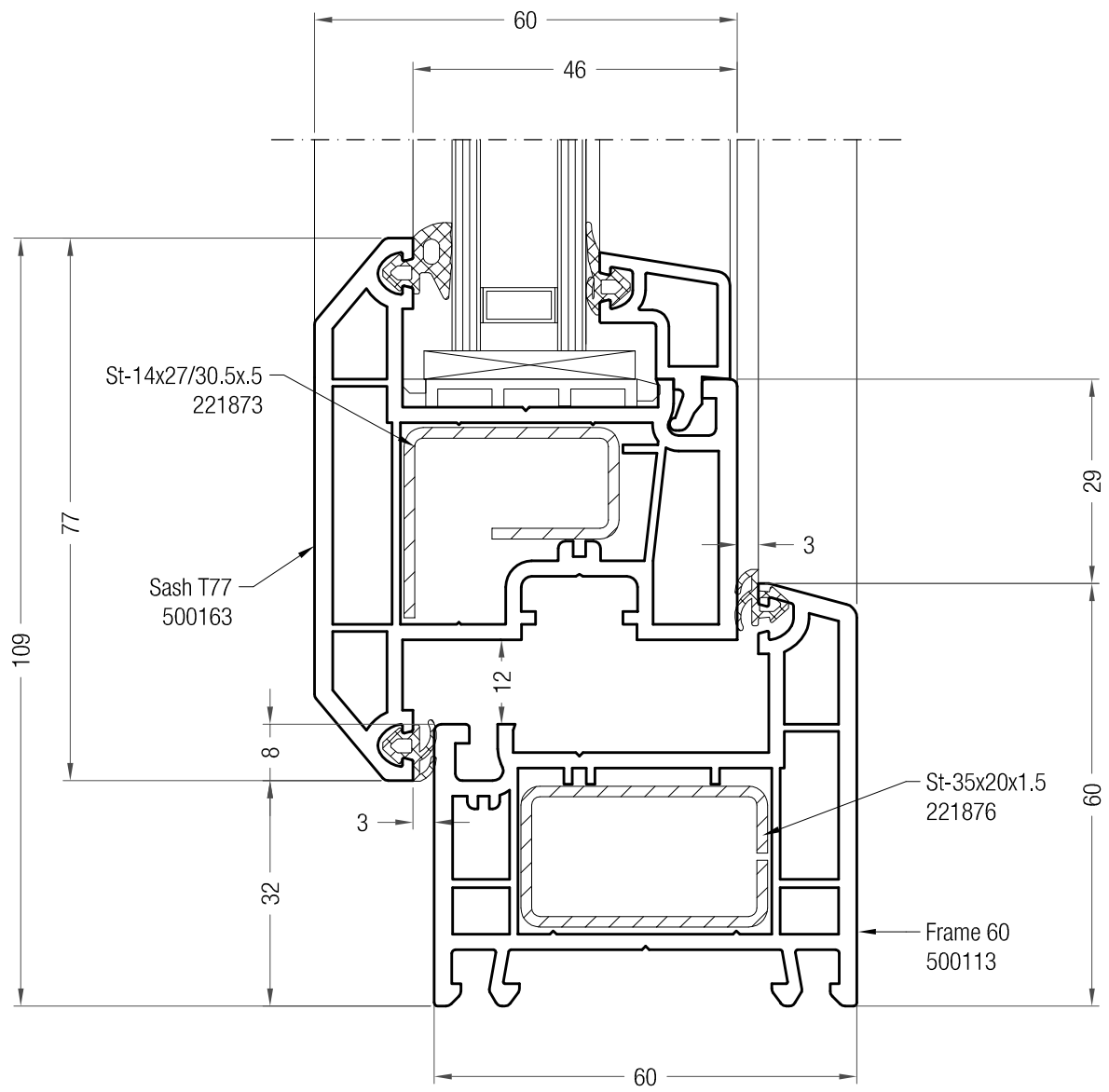
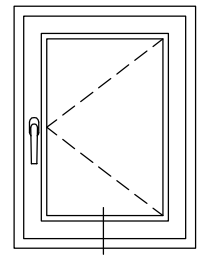

Detail Drawing - Outward Open Window with Fixed Side-Window

Outward Window Sash T77 / Mullion Z82

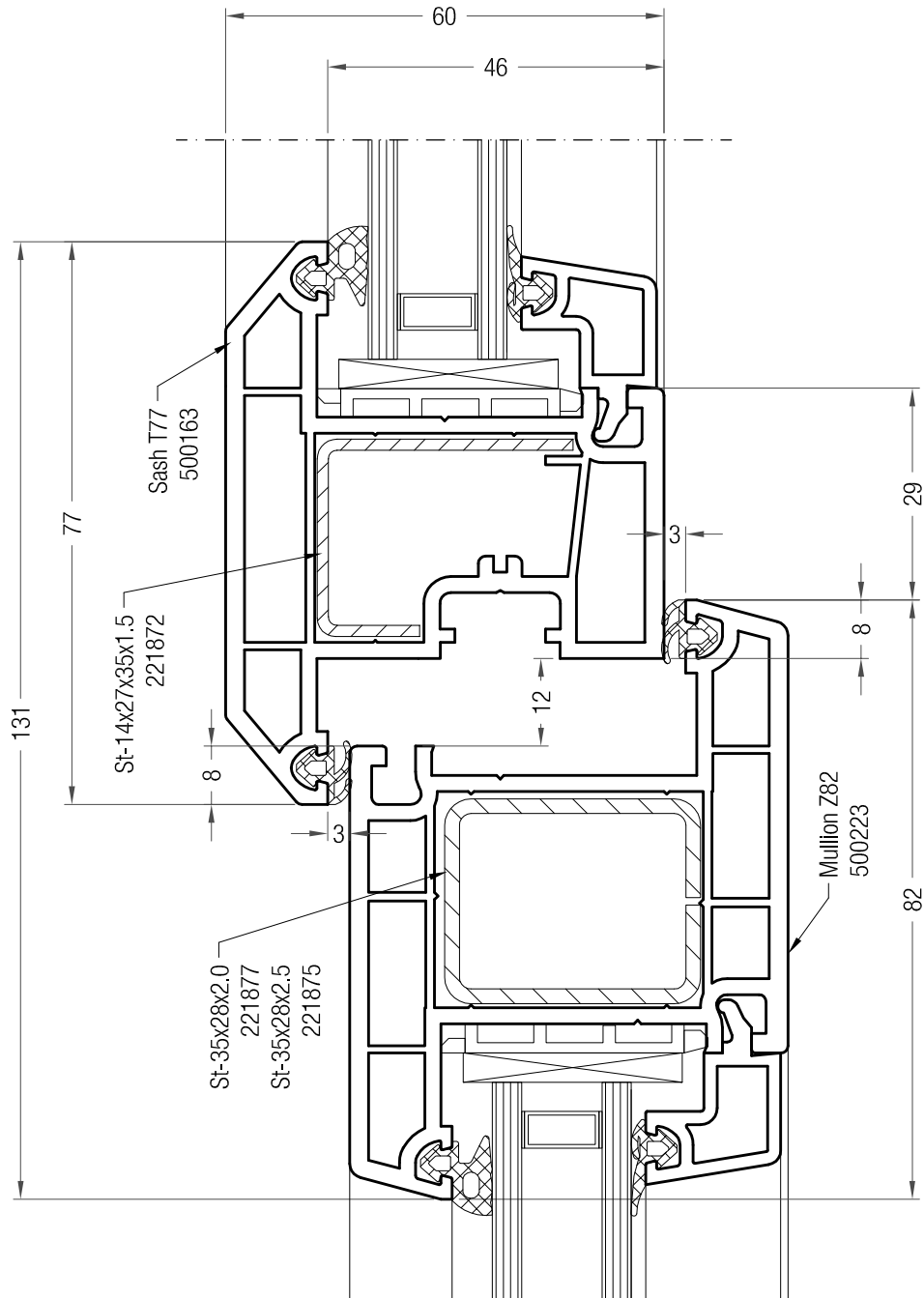
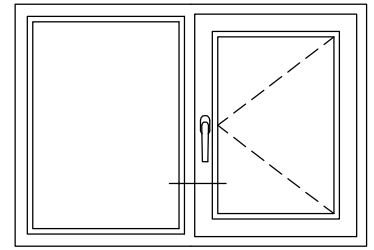

Detail Drawing - 2-Panel Outward Open Window

Outward Window Sash T77 / Mullion T82

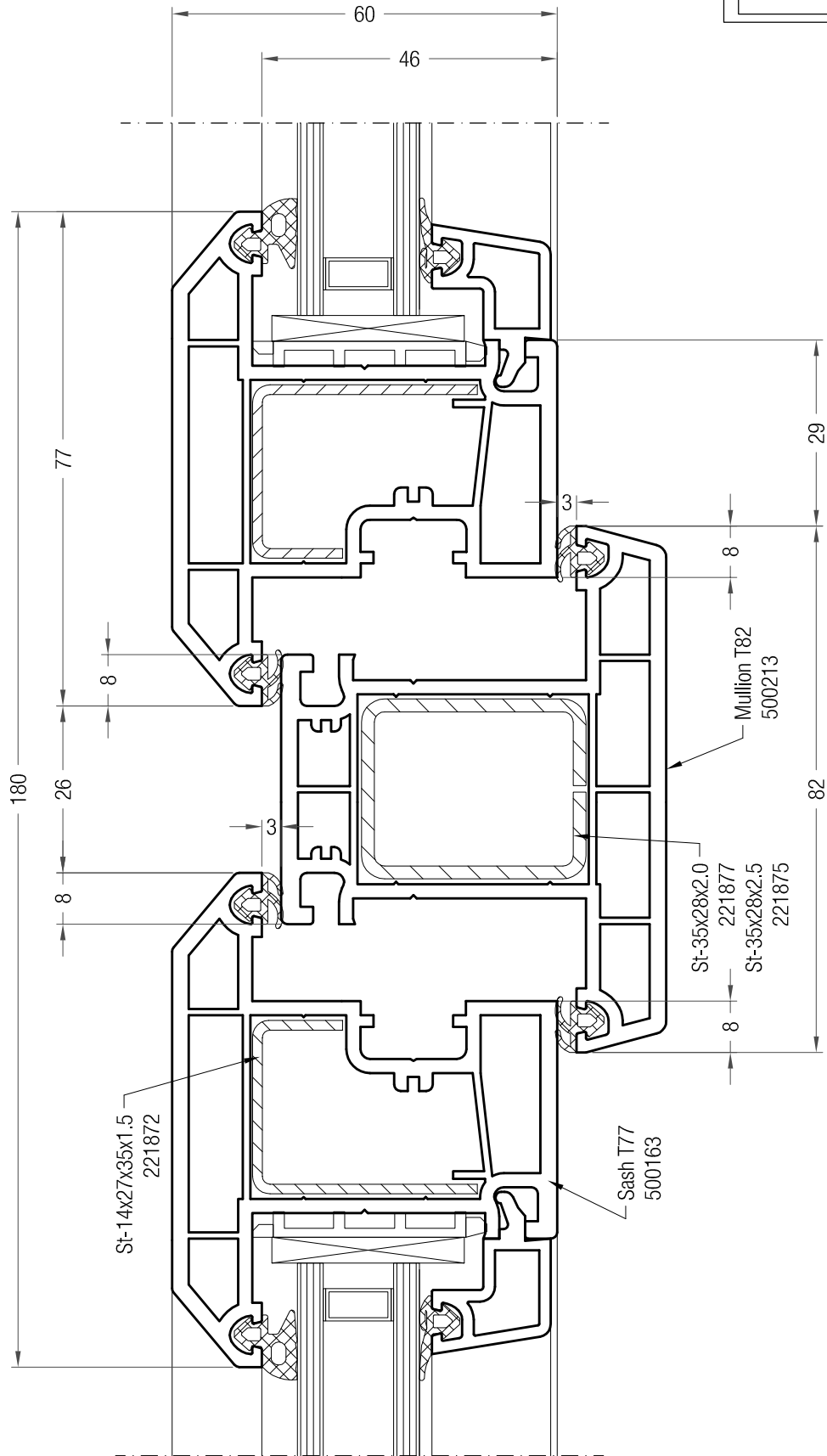
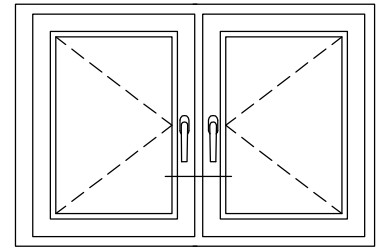

Detail Drawing - Double-Leaf Outward Open Window

Outward Window Sash T77 / Mullion 70 (Dummy Mullion, Outward Open)

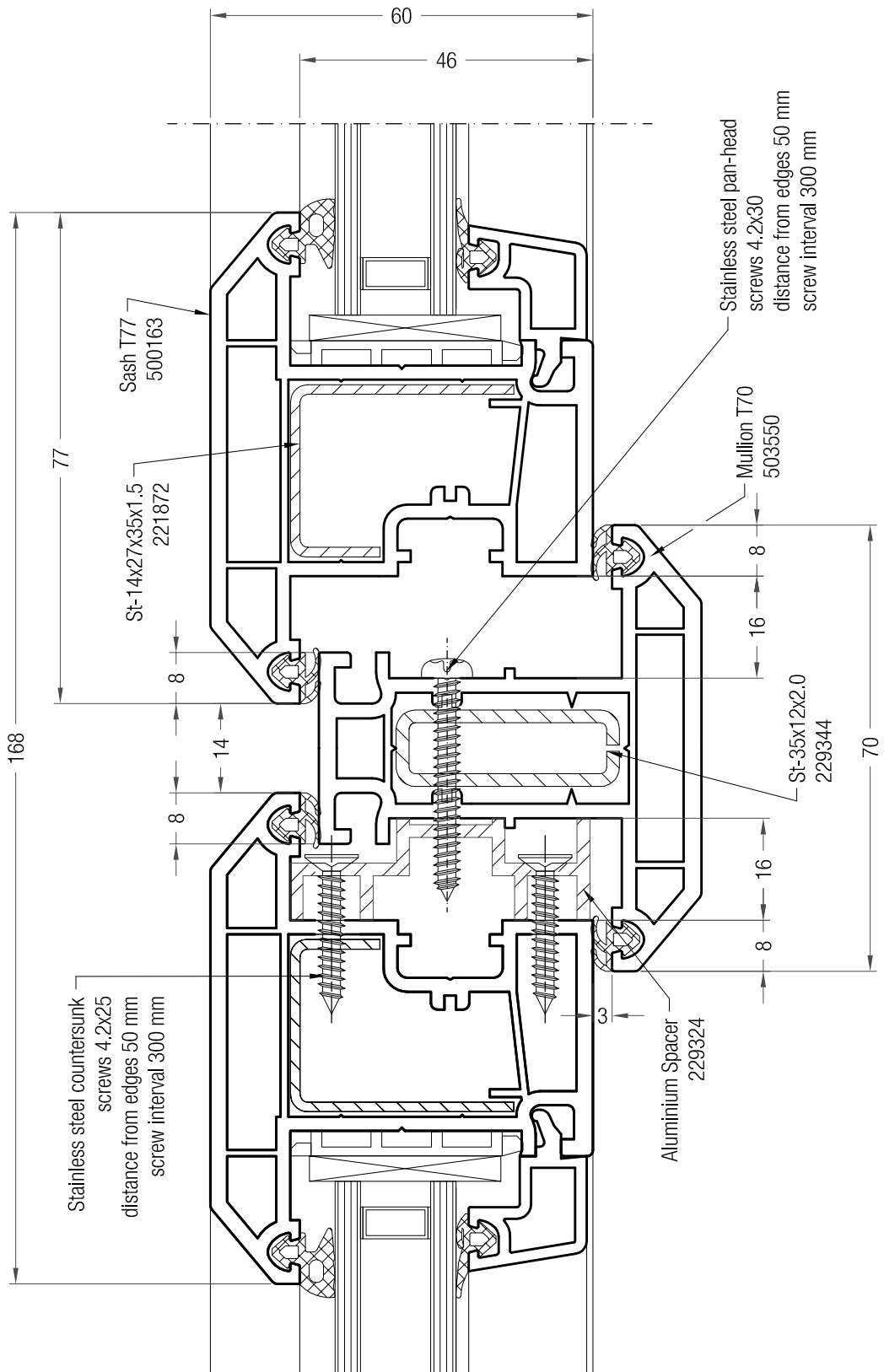
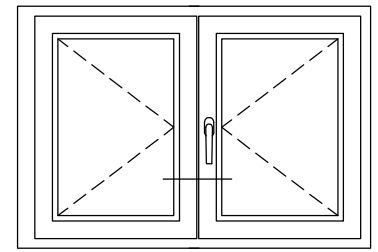



Detail Drawing - Inward Open Door

Frame 76 / Sash Z84 / U-shape steel reinforcement

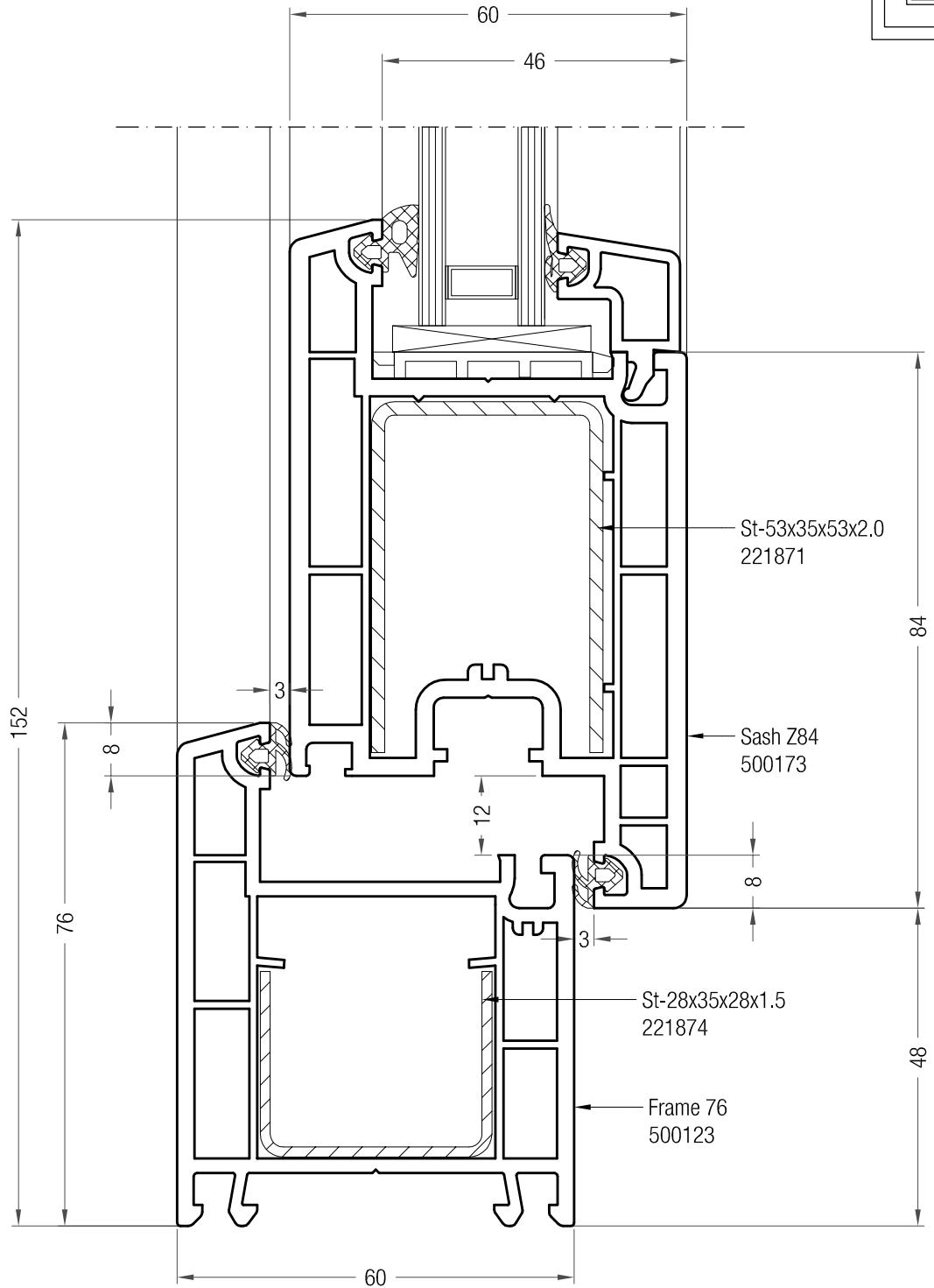
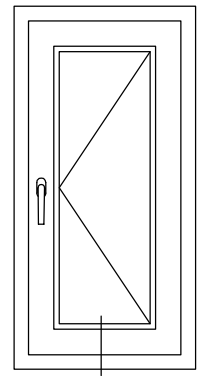



Detail Drawing - Inward Open Door

Aluminium Threshold 4 (thermal break) / Sash Z84

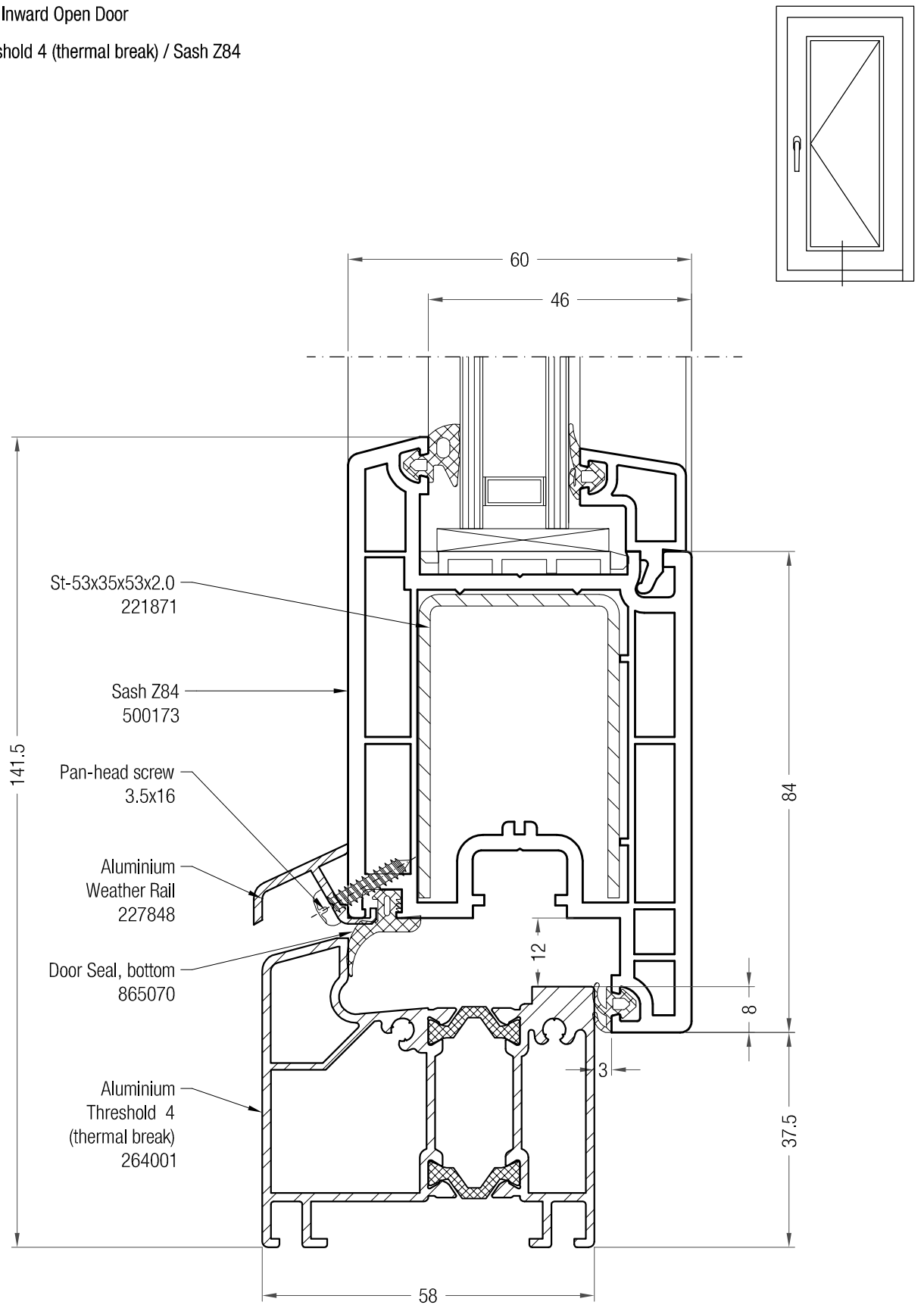

Detail Drawing - Inward Open Door

Aluminium Threshold 3 (thermal break) / Sash Z84

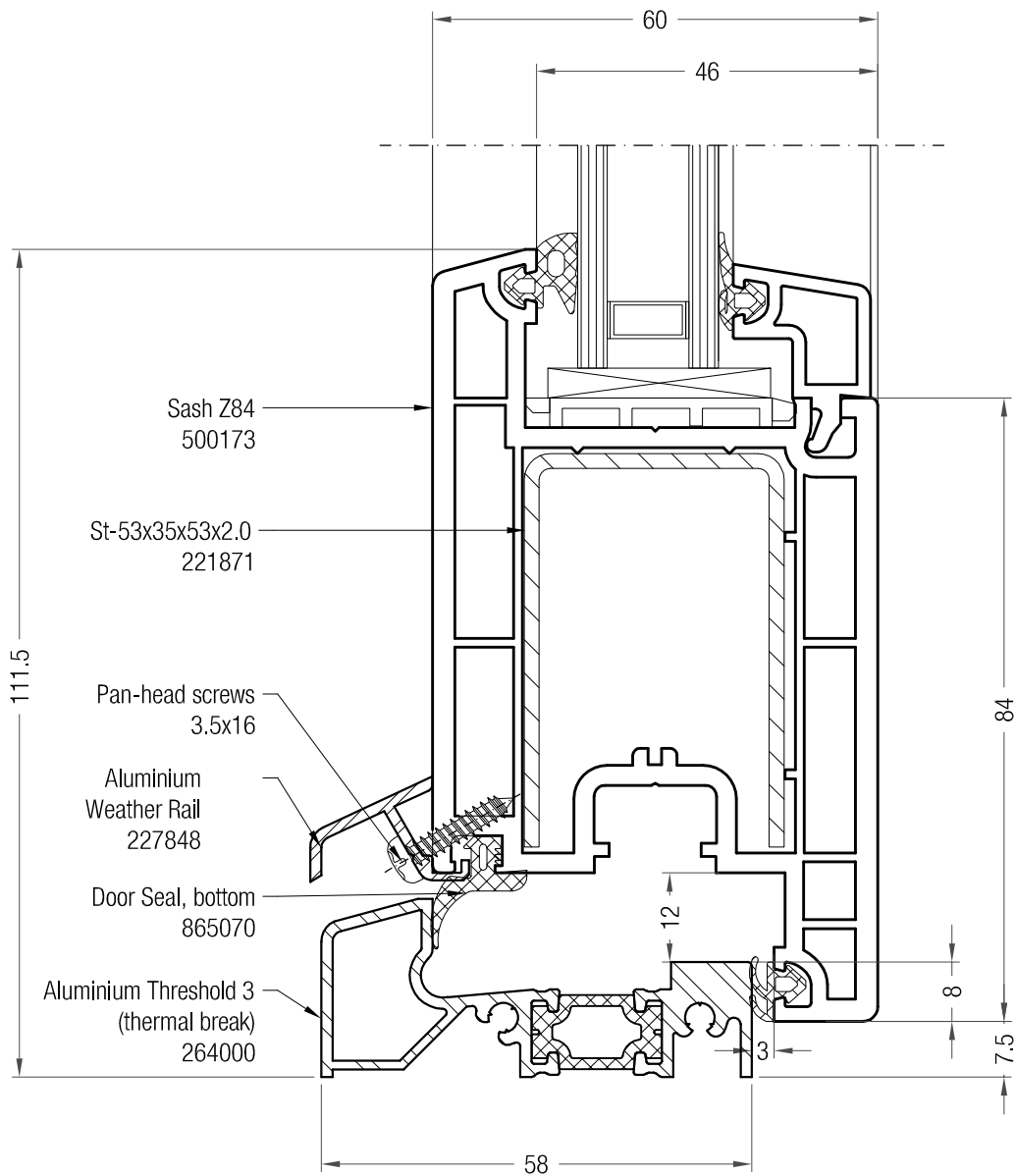
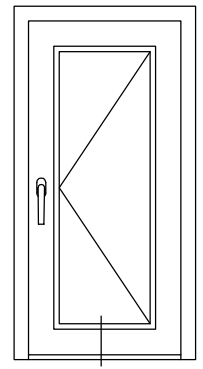

Detail Drawing - Inward Open Door

Aluminium Threshold 2 (low) / Sash Z84

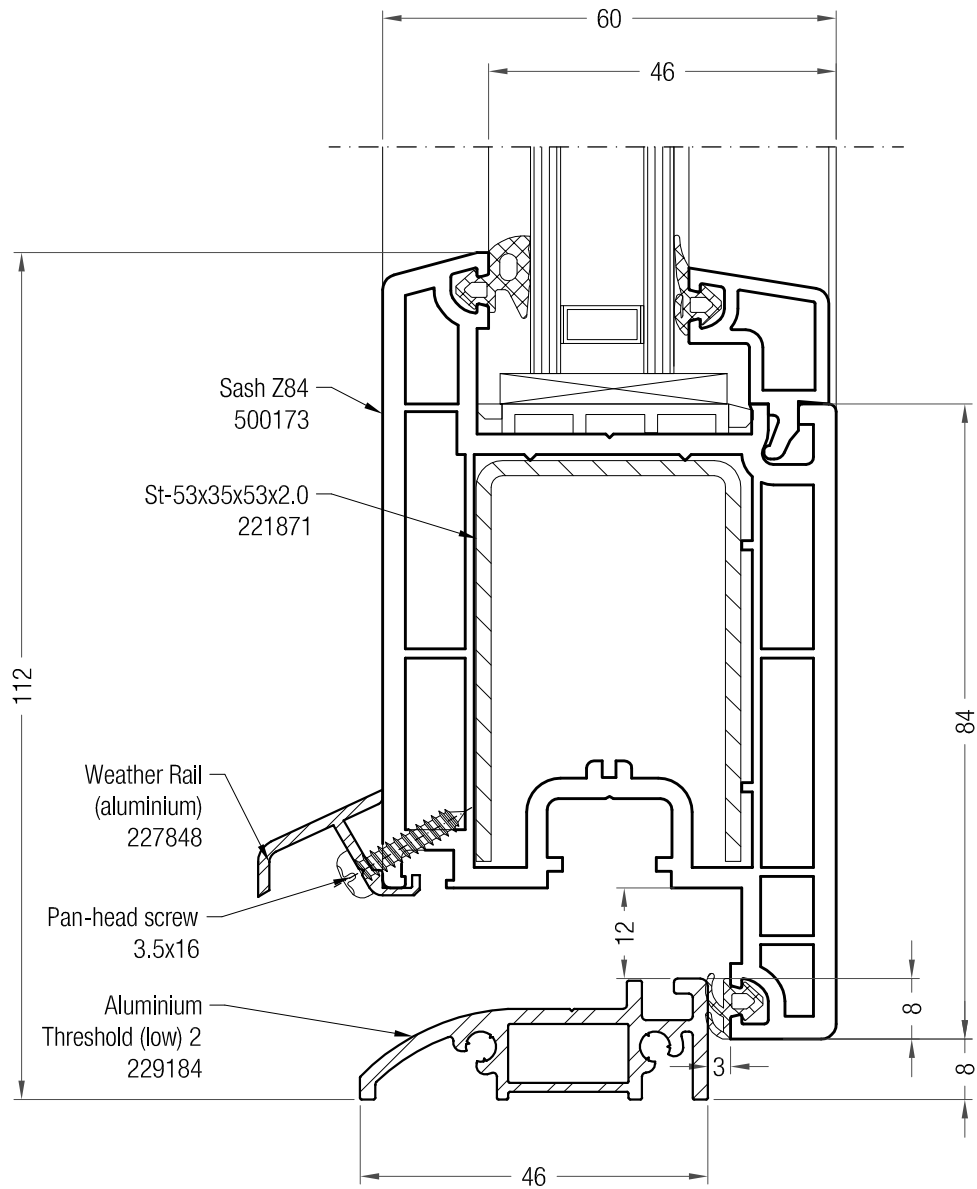
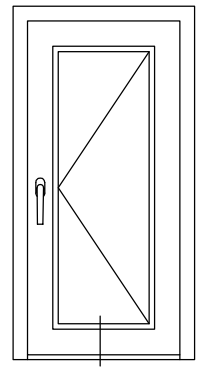

Detail Drawing - Inward Open Door with Fixed Side-Window

Sash Z84 / Mullion T82

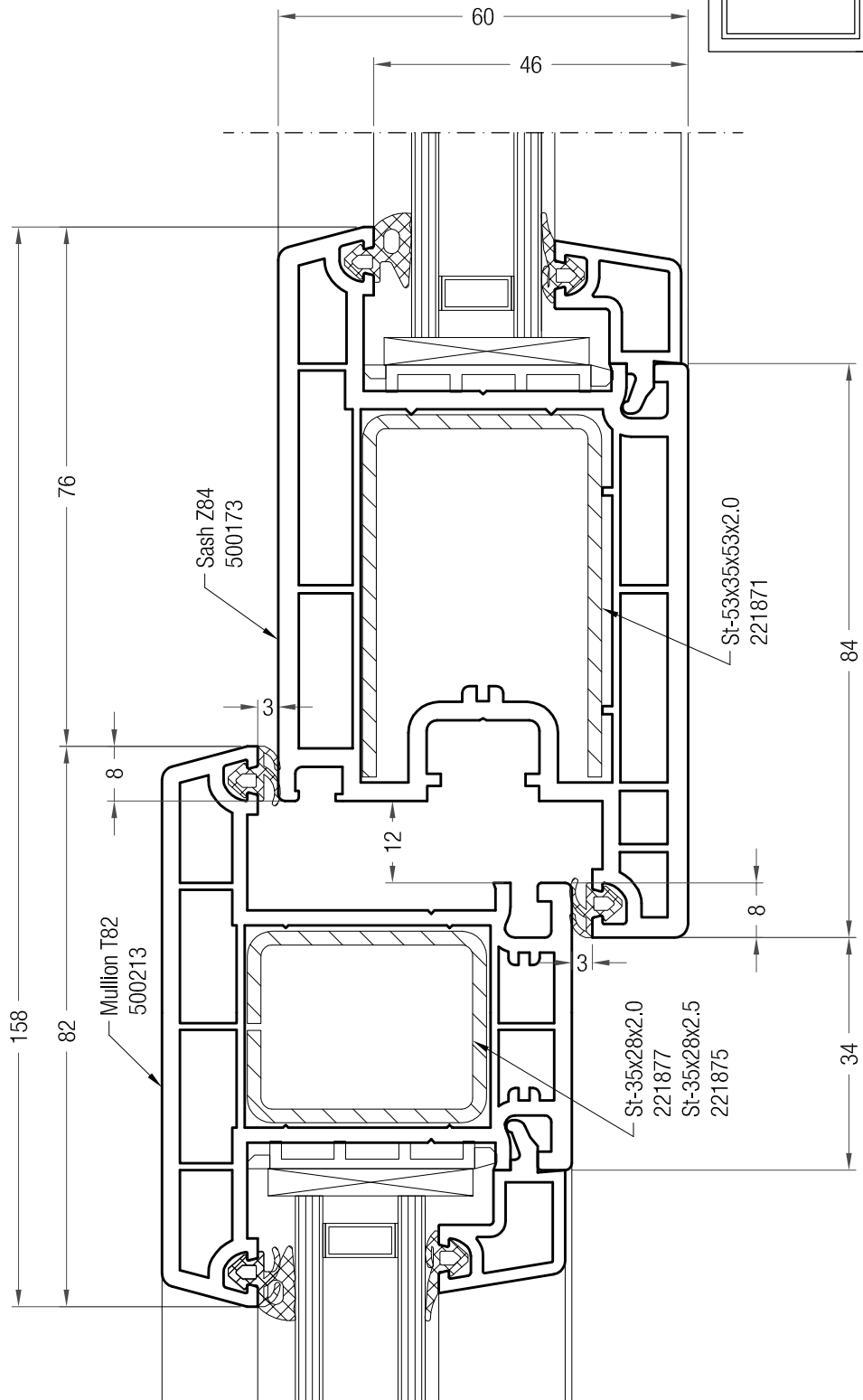

Detail Drawing - Inward Open French door

Sash Z84 / Dummy Mullion

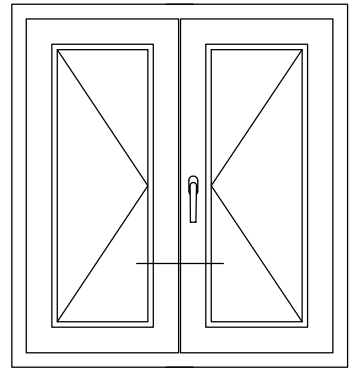
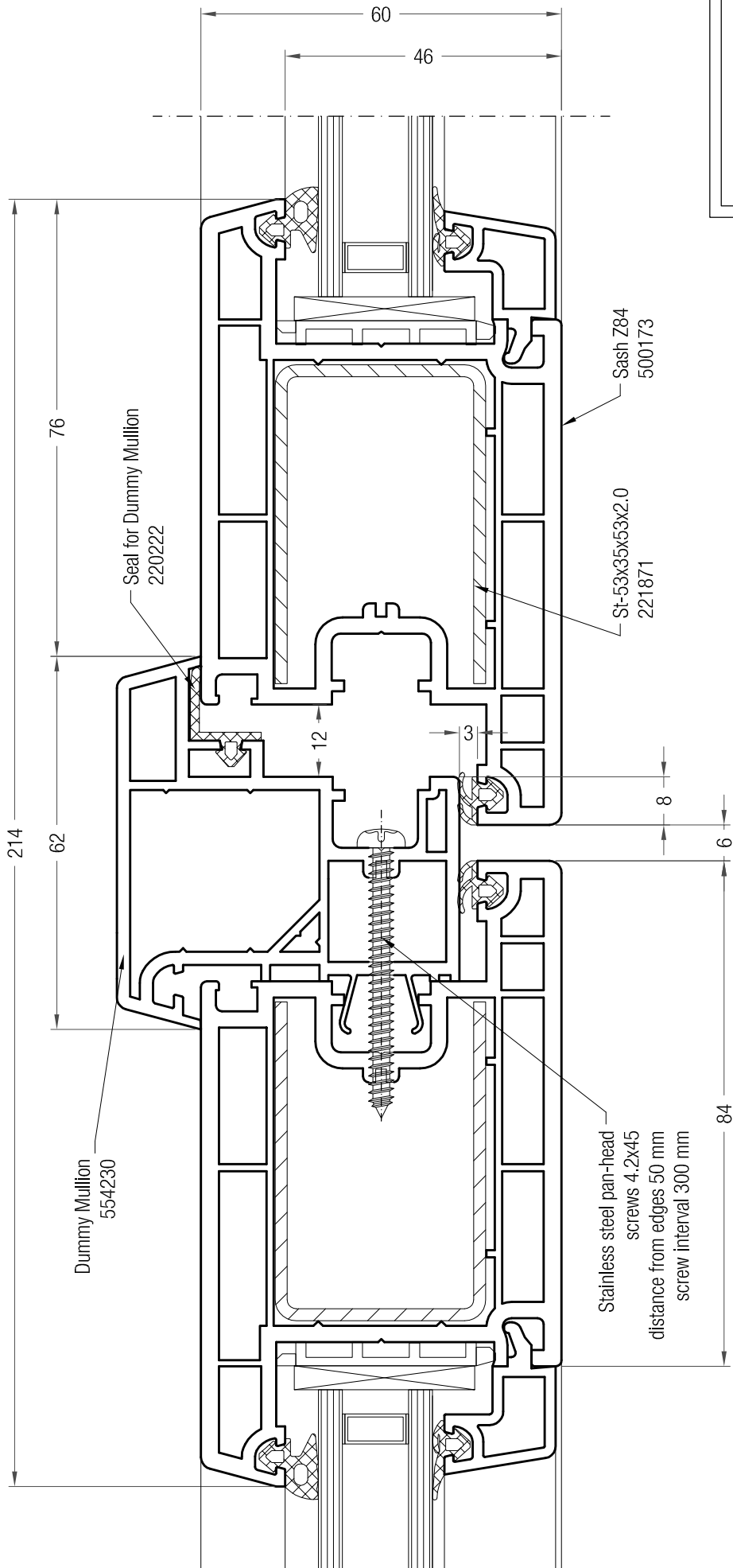

Detail Drawing - Outward Open Door

Frame 76 / Sash T104 / U-shape steel reinforcement

